



DF-G2 High-Speed Expert Dual Display Fiber Amplifier with Dual Discrete Outputs and IO-Link Product Manual

Original Instructions

p/n: 193602 Rev. E

10-Mar-26

© Banner Engineering Corp. All rights reserved. www.bannerengineering.com

Contents

Chapter 1 Features	3
Models	3
Overview	4
Top Panel Interface	4
Specifications	5
Excess Gain Curves	6
Beam Patterns	8
Dimensions	11
Chapter 2 Installation Instructions	12
Mounting Instructions	12
Mount on a DIN Rail	12
Mount to the Accessory Bracket (SA-DIN-BRACKET)	12
Remove from a DIN rail	12
Installing the Fibers in a DF-Gx Sensor	13
Fiber Adapters	13
Wiring Diagrams	14
Chapter 3 Operating Instructions	15
Run Mode	15
Program Mode	15
Output Selection	17
TEACH Selection	18
Response Speeds	18
Offset Percent	18
Auto Thresholds	18
Delays/Timers	19
Sensitivity Selection	19
Display Readout	19
Gain Selection	20
Factory Defaults	20
Remote Input	20
Sync Master/Slave	20
Adjust Mode	21
TEACH Procedures	21
Chapter 4 IO-Link Interface	31
Chapter 5 Accessories	32
Quick-Disconnect Cordsets	32
Chapter 6 Product Support and Maintenance	35
Troubleshooting	35
Manual Adjustments Disabled	35
Percent Minimum Difference after TEACH	35
Percent Offset after SET	35
Threshold Alert or Threshold Error	35
Banner Engineering Corp Limited Warranty	35

Chapter Contents

Models 3
 Overview 4
 Top Panel Interface 4
 Specifications 5

Chapter 1 Features

Advanced sensor with dual discrete outputs and IO-Link communication for use with plastic and glass fiber-optic assemblies

- Response speeds of: 50 μ s, 250 μ s, 500 μ s, 1000 μ s, and 2000 μ s allow for optimization for fast responses, long-distance applications, or noisy environments
- Outstanding color contrast sensitivity; detects 32 levels of gray scale from black to white
- Visible red and IR beam color models available
- Easy to read dual digital displays show both signal level and threshold simultaneously
- Lever-action fiber clamp provides stable, reliable, and trouble-free fiber clamping
- Simple user interface ensures easy sensor set-up and programming through displays and switches/buttons or remote input teach wire
- Expert TEACH and SET methods ensure optimal gain and threshold for all applications, especially for high-speed or low-contrast applications
- User has full control over all operating parameters: threshold, Light Operate or Dark Operate, output timing functions, gain level, and response speed
- Thermally stable electronics shortens start-up time and maintains signal stability during operation
- ECO (economy) display mode reduces amplifier power consumption by 25%
- Cross-talk avoidance algorithm allows two sensors to operate in close proximity for many applications
- Sleek 10 mm wide housing mounts to 35 mm DIN rail

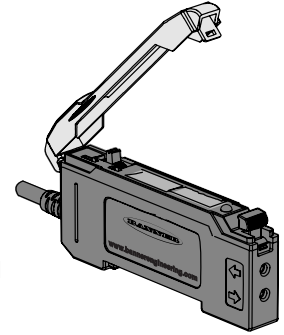

WARNING:



- **Do not use this device for personnel protection**
- Using this device for personnel protection could result in serious injury or death.
- This device does not include the self-checking redundant circuitry necessary to allow its use in personnel safety applications. A device failure or malfunction can cause either an energized (on) or de-energized (off) output condition.

Models

Model	Sensing Beam Color	Reference Sensing Range ⁽¹⁾	Channel 1	Channel 2	Connector
DF-G2-KD-2M	Visible red	1100 mm	IO-Link push/pull output	PNP only output, or input	2 m (6.5 ft) cable, 4-wire
DF-G2-KD-Q3					150 mm (6 in) PVC cable with a 4-pin M8 quick disconnect
DF-G2-KD-Q5					150 mm (6 in) PVC cable with a 4-pin M12 quick disconnect
DF-G2-KD-Q7					4-pin M8 quick disconnect
DF-G2IR-KD-Q5	Infrared	2100 mm	IO-Link push/pull output	PNP only output, or input	150 mm (6 in) PVC cable with a 4-pin M12 quick disconnect
DF-G2IR-KD-Q7					4-pin M8 quick disconnect

⁽¹⁾ Excess gain = 1, Long Range response speed, opposed mode sensing. PIT46U plastic fiber used for visible LED models, IT.83.3ST5M6 glass fiber used for IR model

A model with a QD connector requires a mating cordset.

The following models are no longer available for order but are still covered by the information in this document.

Model	Sensing Beam Color	Reference Sensing Range	Channel 1	Channel 2	Connector
DF-G2IR-KD-2M	Infrared	2100 mm	IO-Link, push/pull output	PNP only output, or input	2 m (6.5 ft) cable, 4-wire
DF-G2IR-KD-Q3					150 mm (6 in) PVC cable with a 4-pin M8 quick disconnect

Overview

The DF-G2 is an easy-to-use, DIN-rail-mountable fiber optic sensor with best-in-class response speed and repeatability. It provides high-performance sensing in high-speed or low-contrast applications where fast response time is required.

The sensor's compact housing has dual digital displays (Red/Green) and a bright output LED for easy programming and status monitoring during operation. The sensor features a push-pull primary output that supports IO-link communication, and a multi-function secondary independent PNP output that can be configured as an input for advanced sensor configuration and remote teach.

The DF-G2 features improved temperature compensation compared with previous fiber optic sensors. An accessory clamp is available to secure a bank of connected sensors together on a DIN rail (see Accessories).

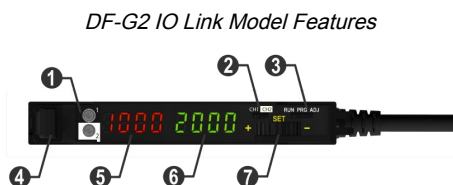

1. Output LED
2. CH1/CH2 Switch
3. RUN/PRG/ADJ Mode Switch
4. Lever Action Fiber Clamp
5. Red Signal Level
6. Green Threshold
7. +/SET/- Rocker Button

Top Panel Interface

Opening the dust cover provides access to the top panel interface. The top panel interface consists of the RUN/PRG/ADJ mode switch, CH1/CH2 switch, +/SET/- rocker button, dual red/green digital displays, and output LED.



RUN/PRG/ADJ Mode Switch

The RUN/PRG/ADJ mode switch puts the sensor in RUN, PRG (Program), or ADJ (Adjust) mode.

- RUN mode allows the sensor to operate normally and prevents unintentional programming changes via the +/SET/- rocker button.
- PRG mode allows the sensor to be programmed through the display-driven programming menu (see Program Mode).
- ADJ mode allows the user to perform Expert TEACH/SET methods and Manual Adjust (see Adjust Mode).



CH1/CH2 Switch (Dual Output Mode)

The CH1/CH2 switch selects which output's parameters can be accessed and changed in the interface of the display.

Continued on page 5

Continued from page 4

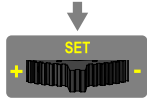

+/-SET/- Rocker Button

The +/-SET/- rocker button is a 3-way button. The +/- positions are engaged by rocking the button left/right. The SET position is engaged by clicking down the button while the rocker is in the middle position. All three button positions are used during PRG mode to navigate the display-driven programming menu. During ADJ mode, SET is used to perform TEACH/SET methods and +/- are used to manually adjust the threshold(s). The rocker button is disabled during RUN mode, except when using Window SET.



Red/Green Digital Displays

During RUN and ADJ modes, the Red display shows the signal level, and the Green display shows the threshold or the total counts. During PRG mode, both displays are used to navigate the display-driven programming menu.

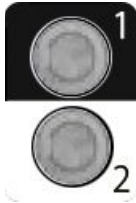

Dual Output LEDs

The output LEDs provide a visible indication when the associated output is active (conducting).

- 1 represents the Channel 1 output
- 2 represents the Channel 2 output

Specifications

Sensing Beam

DF-G2: Visible red, 635 nm
DF-G2IR: Infrared, 850 nm

Supply Voltage

10 V DC to 30 V DC Class 2 (10% maximum ripple)

Power and Current Consumption (exclusive of load)

Standard display mode: 960 mW, Current consumption < 40 mA at 24 V DC

ECO display mode: 720 mW, Current consumption < 30 mA at 24 V DC

Supply Protection Circuitry

Protected against reverse polarity and transient overvoltages

Delay at Power-Up

500 milliseconds maximum; outputs do not conduct during this time

Output Configuration

CH1 = IO-Link, Push/pull
CH2 = PNP only output or input

Output Rating

100 mA maximum load each output (derate 1 mA per °C above 30° C)

100 mA max total load current for sensor

OFF-state leakage current: < 5 µA PNP at 30 V DC (N.A. push/pull);

ON-state saturation voltage: < 2 V

Required Overcurrent Protection



WARNING: Electrical connections must be made by qualified personnel in accordance with local and national electrical codes and regulations.

Overcurrent protection is required to be provided by end product application per the supplied table.

Overcurrent protection may be provided with external fusing or via Current Limiting, Class 2 Power Supply.

Supply wiring leads < 24 AWG shall not be spliced.

For additional product support, go to www.bannerengineering.com.

Supply Wiring (AWG)	Required Overcurrent Protection (A)	Supply Wiring (AWG)	Required Overcurrent Protection (A)
20	5.0	26	1.0
22	3.0	28	0.8
24	2.0	30	0.5

IO-Link Interface

Supports smart sensor profile: Yes

Baud rate: 38400 bps

Process data widths: 16 bits

IODD files: Provides all programming options of the display, plus additional functionality

Output Protection

Protected against output short-circuit, continuous overload, transient overvoltages, and false pulse on power-up

Construction

Black ABS/polycarbonate alloy (UL94 V-0 rated) housing, clear polycarbonate cover

Connections

PVC jacketed 2 m (6.5 ft) 4-wire integral cable; or integral 4-pin M8 quick disconnect; or 150 mm (6 inch) cable with a 4-pin M12 quick disconnect; or 150 mm (6 inch) cable with a 4-pin M8 quick disconnect

Adjustments

- 3-way RUN/PRG/ADJ Mode Switch
- 2-way CH1/CH2 Switch
- 3-way +/SET/- Rocker Button
 - Expert-style teaching (Two-Point and Dynamic TEACH, Light/Dark/Window/Calibration SET)
 - Manually adjust sensitivity (from "+" and "-" rocker button only)
 - Response Speed, TEACH Selection, Offset Percent, Auto Thresholds, Delays/Timers, Display Readout, Gain Selection, Factory Defaults (from top panel or remote input)
 - Top panel interface lockout (from remote input only)

Indicators

- Red 4-digit Display:** Signal Level
- Green 4-digit Display:** Threshold
(In Program Mode, Red and Green displays are used for programming menus)
- Amber LED:** Output conducting

Environmental Rating

IP50, NEMA 1

Operating Conditions

- Temperature:** -10 °C to +55 °C (+14 °F to +131 °F)
- Storage Temperature:** -20 °C to +85 °C (-4 °F to +185 °F)
- Humidity:** 90% at +60 °C maximum relative humidity (non-condensing)

Certifications



Response Speed

See "Response Speeds" on page 18

Excess Gain Curves

The excess gain curves shown are for the standard red LED and IR850 LED emitter models.

The data in the charts that is labeled for the Long Range application apply to both the 1000 μs and 2000 μs response speeds.

0.25 mm (0.01 in) Diameter Fibers

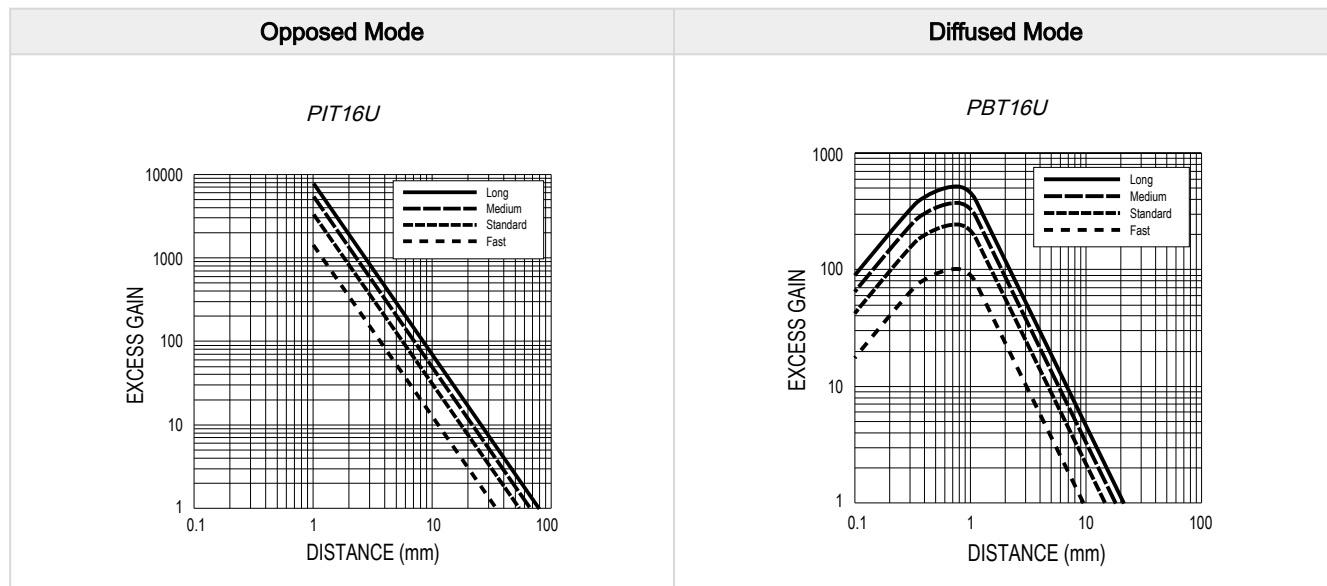

0.51 mm (0.02 in) Diameter Fibers

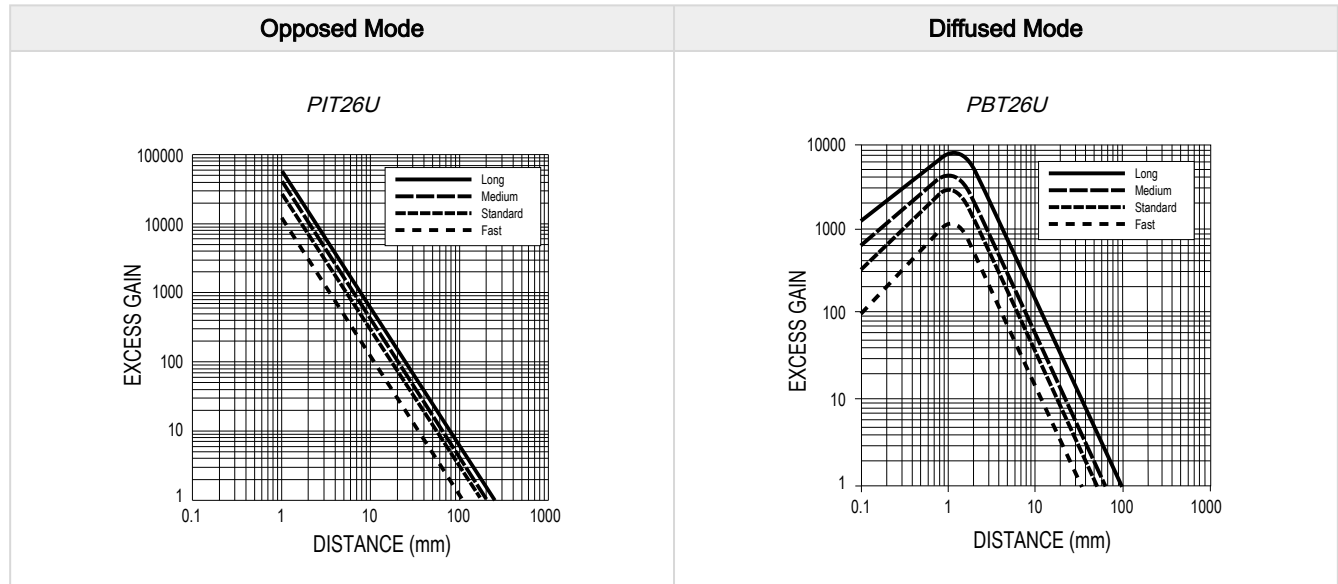

1.02 mm (0.04 in) Diameter Fibers

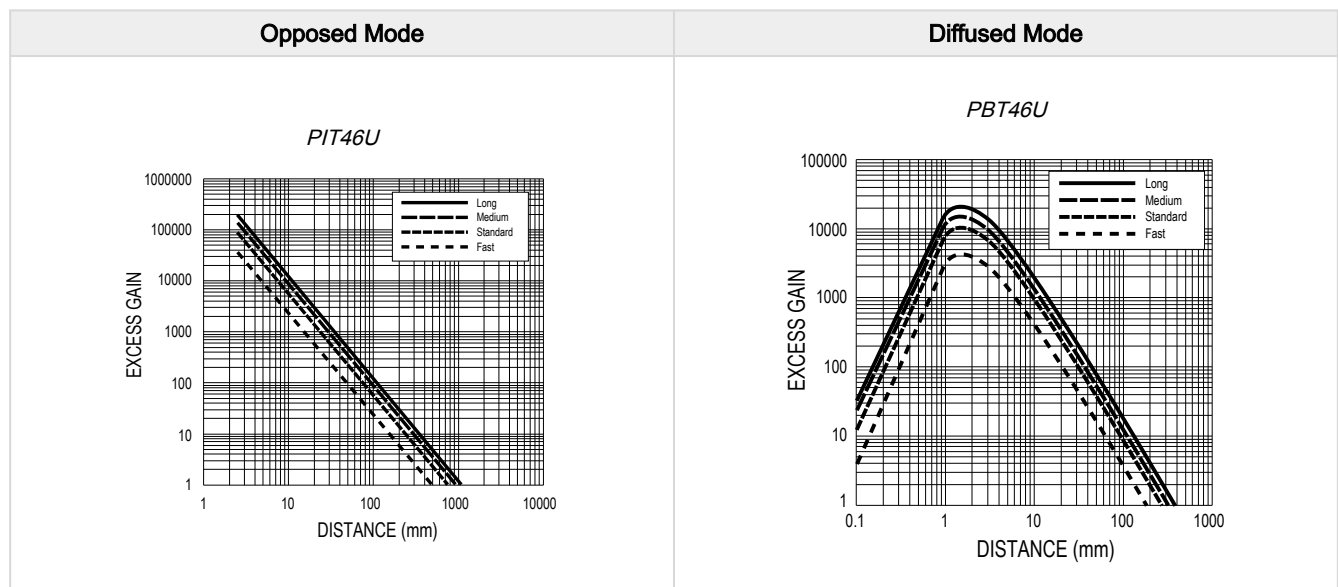

1.52 mm (0.06 in) Diameter Fibers

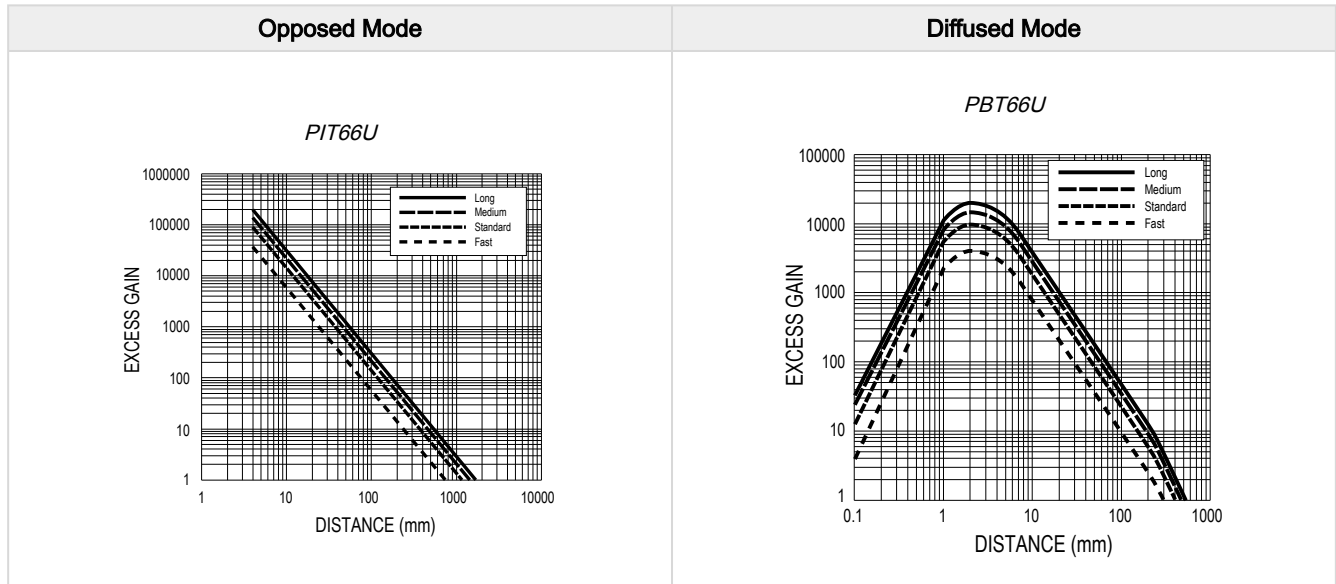

IT.83.3ST5M6 glass fiber used for opposed mode; *BTC1.13.4.T5M6* glass fiber used for diffuse mode

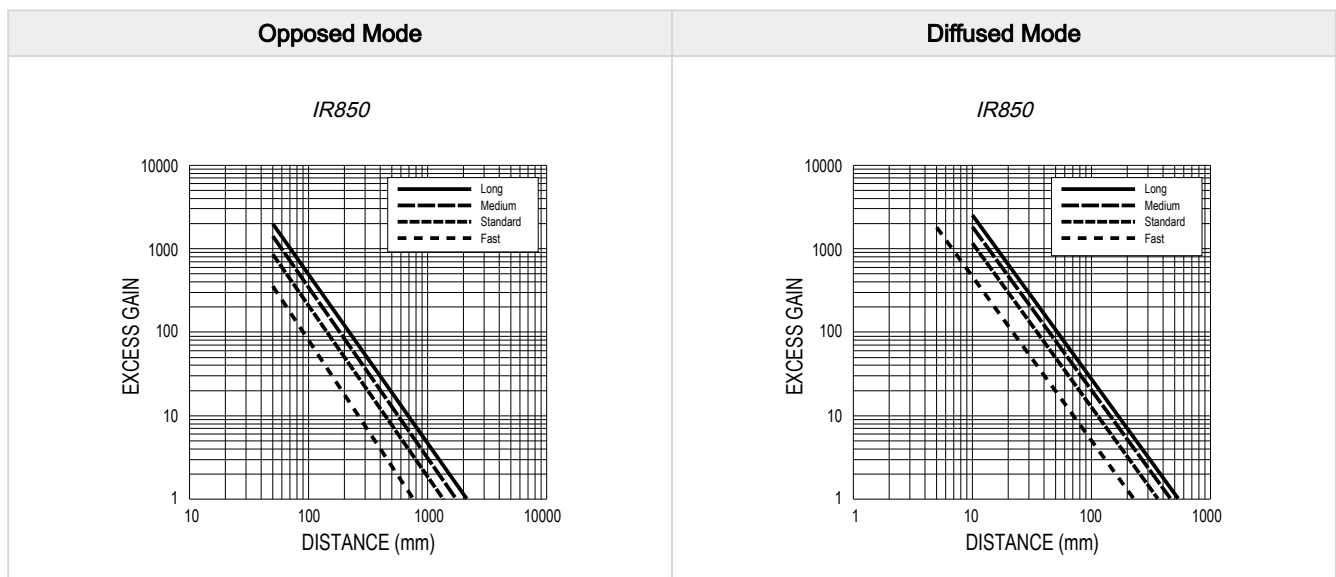

Beam Patterns

The beam patterns shown are for the standard red LED and IR850 LED emitter models.

The data in the charts that is labeled for the Long Range application apply to both the 1000 μ s and 2000 μ s response speeds.

0.25 mm (0.01 in) Diameter Fibers

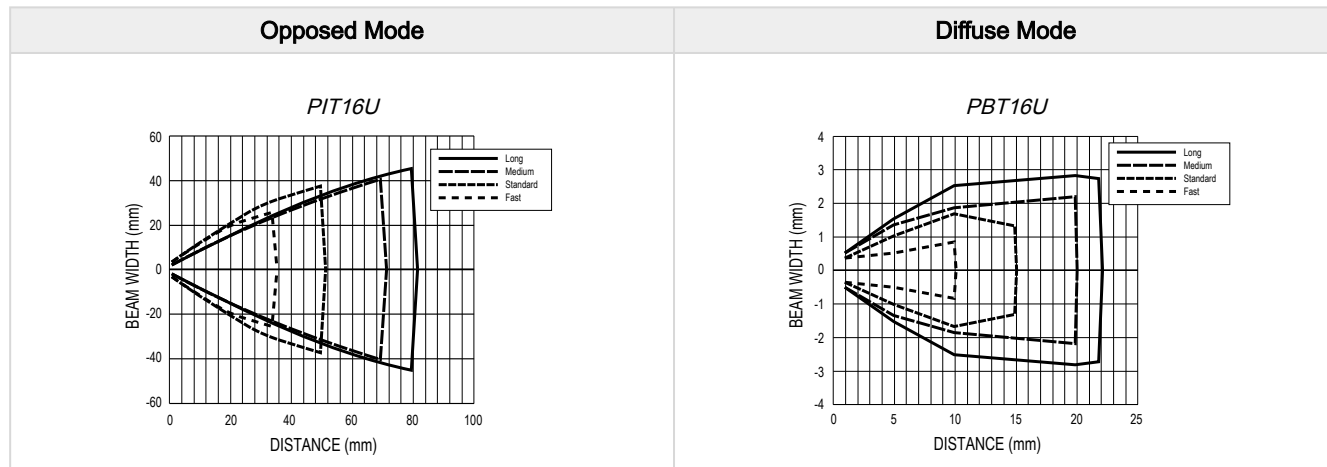

0.51 mm (0.02 in) Diameter Fibers

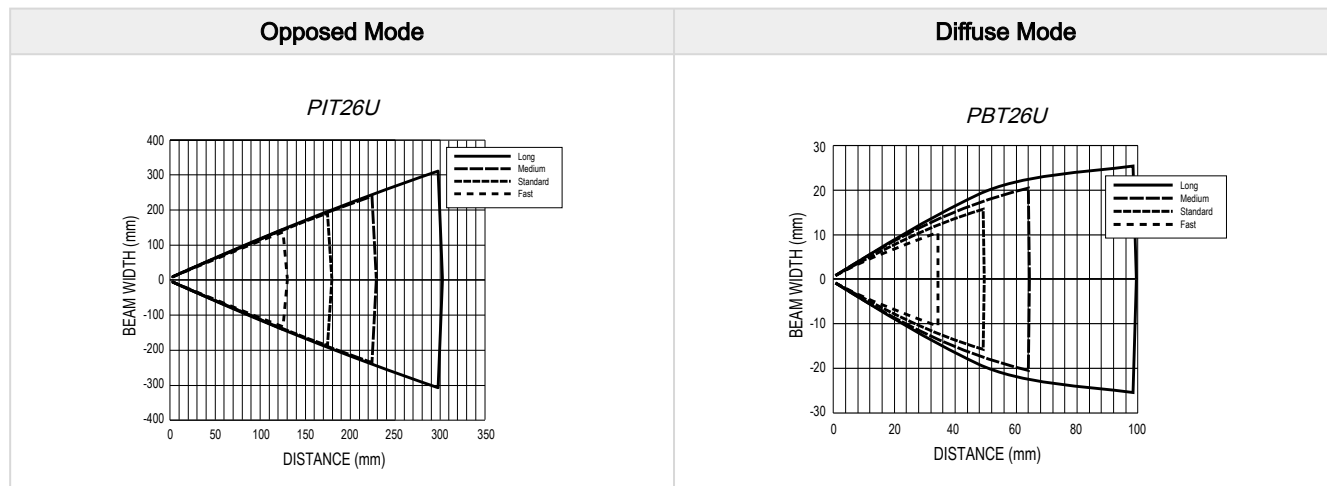

1.02 mm (0.04 in) Diameter Fibers

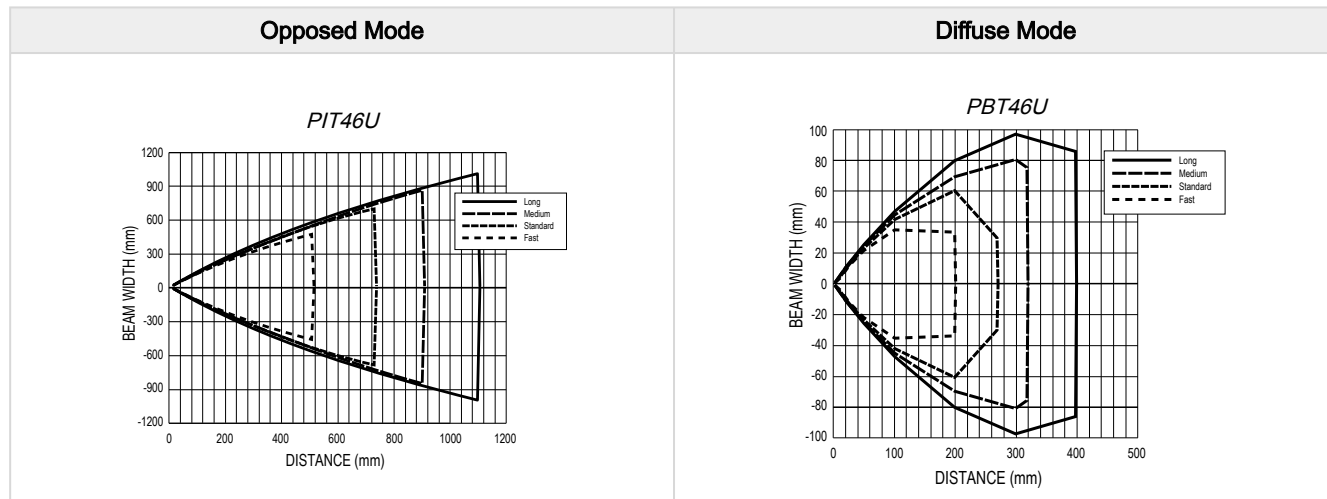

1.52 mm (0.06 in) Diameter Fibers

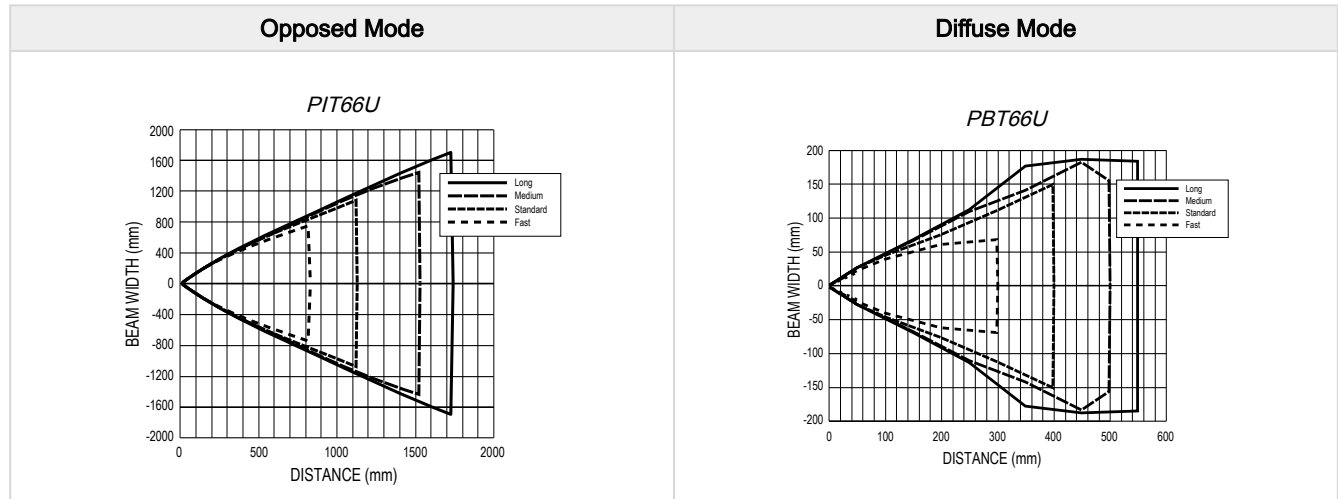

IT.83.3ST5M6 glass fiber used for opposed mode; *BTC1.13.4.T5M6* glass fiber used for diffuse mode

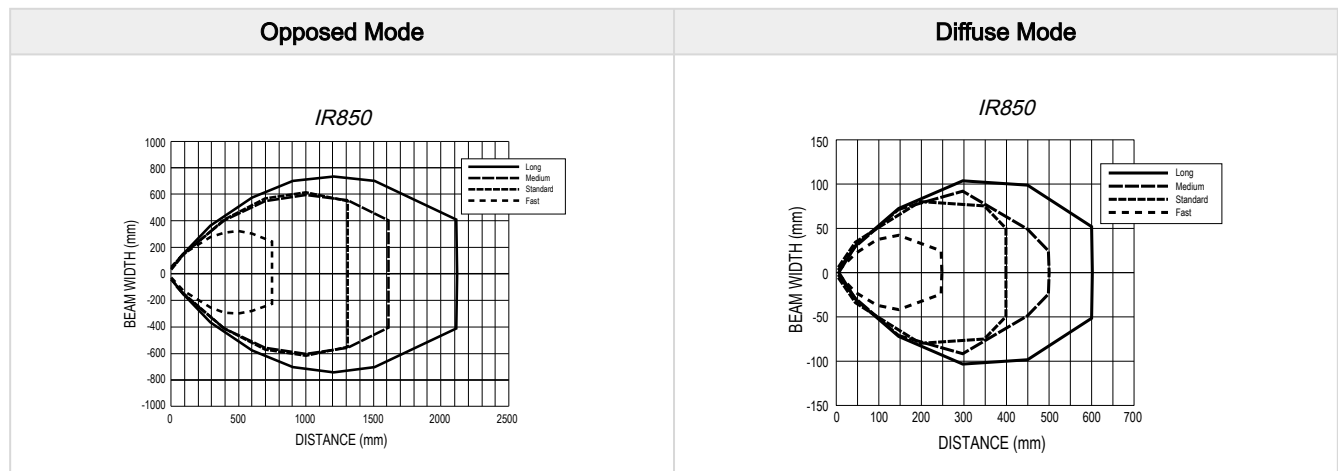

Dimensions

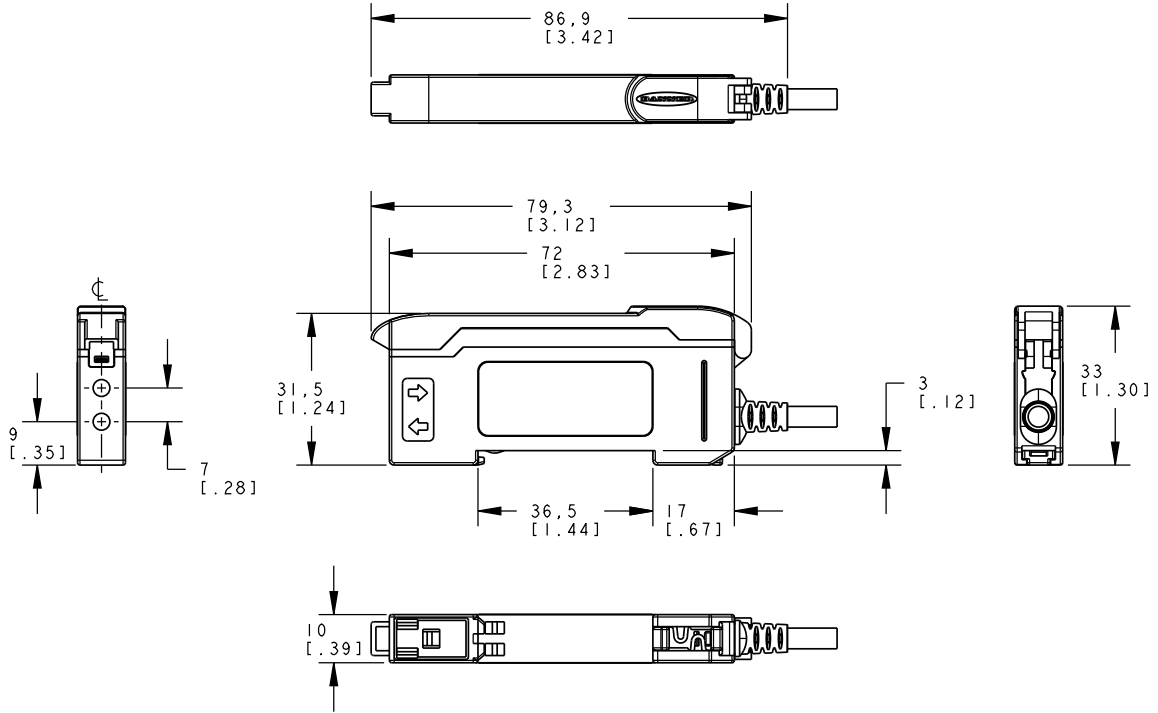

Chapter Contents

Mounting Instructions	12
Mount on a DIN Rail	12
Mount to the Accessory Bracket (SA-DIN-BRACKET)	12
Remove from a DIN rail	12
Installing the Fibers in a DF-Gx Sensor	13
Fiber Adapters	13
Wiring Diagrams	14

Chapter 2 Installation Instructions

Mounting Instructions

Mount on a DIN Rail

1. Hook the DIN rail clip on the bottom of the DF-G2 over the edge of the DIN rail (1).
2. Push the DF-G2 up on the DIN rail (1).
3. Pivot the DF-G2 onto the DIN rail, pressing until it snaps into place (2).

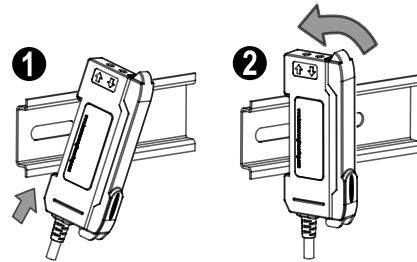

Mount to the Accessory Bracket (SA-DIN-BRACKET)

1. Position the DF-G2 in the SA-DIN-BRACKET.
2. Insert the supplied M3 screws.
3. Tighten the screws.

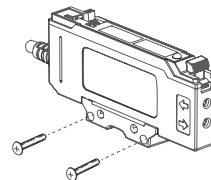

Remove from a DIN rail

1. Push the DF-G2 up on the DIN rail (1).
2. Pivot the DF-G2 away from the DIN rail and remove it (2).

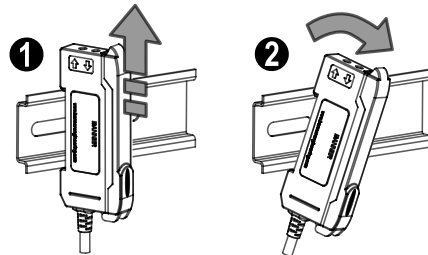

Installing the Fibers in a DF-Gx Sensor

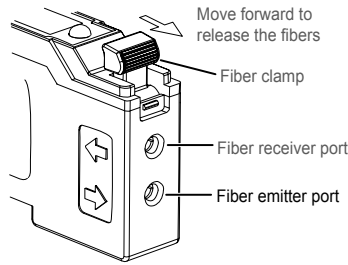

Follow these steps to install glass or plastic fibers.

1. Open the dust cover.
2. Move the fiber clamp forward to unlock it.
3. Insert the fiber(s) into the fiber port(s) until they stop.
4. Move the fiber clamp backward to lock the fiber(s).
5. Close the dust cover.

For optimum performance of IR models, if applicable, glass fibers must be used.

Fiber Adapters

If a thin fiber with less than 2.2 mm outer diameter is used, install the fiber adapter provided with the fiber assembly to ensure a reliable fit in the fiber holder. Align the fibers to the end of the adapters. Banner includes the adapters with all fiber assemblies.

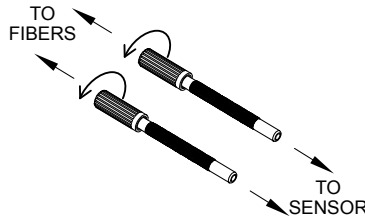

Fiber Outer Diameter (mm)	Adapter Color
Ø 1.0	Black
Ø 1.3	Red
Ø 2.2	No adapter needed

When connecting coaxial-type fiber assemblies to the amplifier, install the single-core (center) fiber to the Transmitter port, and the multi-core (outer) fiber to the Receiver port. This will result in the most reliable detection.

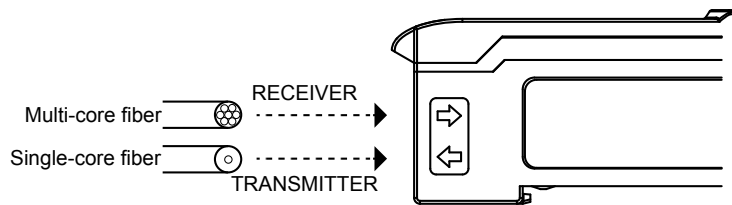

Wiring Diagrams

Channel 1 as a Push-Pull discrete output, Channel 2 as PNP discrete output

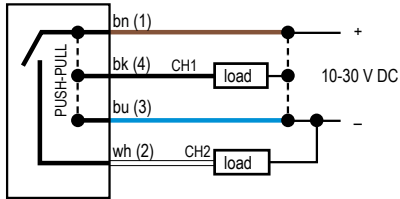

Channel 1 as a Push-Pull discrete output, Channel 2 as remote input

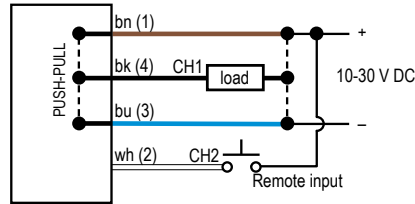

Key

- 1 = Brown
- 2 = White
- 3 = Blue
- 4 = Black

NOTE: Open lead wires must be connected to a terminal block.

NOTE: The Channel 2 wire function is user-selectable. The default is independent Light Operate (LO) PNP output. See the Remote Input section for details regarding use as remote input or the Sync Master/Slave section for use as a synchronization output.

Chapter Contents

Run Mode..... 15
 Program Mode..... 15
 Remote Input..... 20
 Sync Master/Slave 20
 Adjust Mode 21

Chapter 3 Operating Instructions

Run Mode

Run mode allows the sensor to operate normally and prevents unintentional programming changes. The +/-SET/- rocker button is disabled during RUN mode, except when using Window SET.

Program Mode

Program (PRG) mode allows the following settings to be programmed in the DF-G2.

CH 1 Factory Default Settings

Setting	Factory Default
Out SEL1	LO
tch SEL1	2-pt tch
rESP SPd	250 us
OFSt Pct1	10 Pct
Auto thr1	oFF
dLY SEL1	oFF
SEnS SEL1	high
diSP rEAd	diSP 1234
GAin SEL	Auto

CH 1 Program Mode Chart

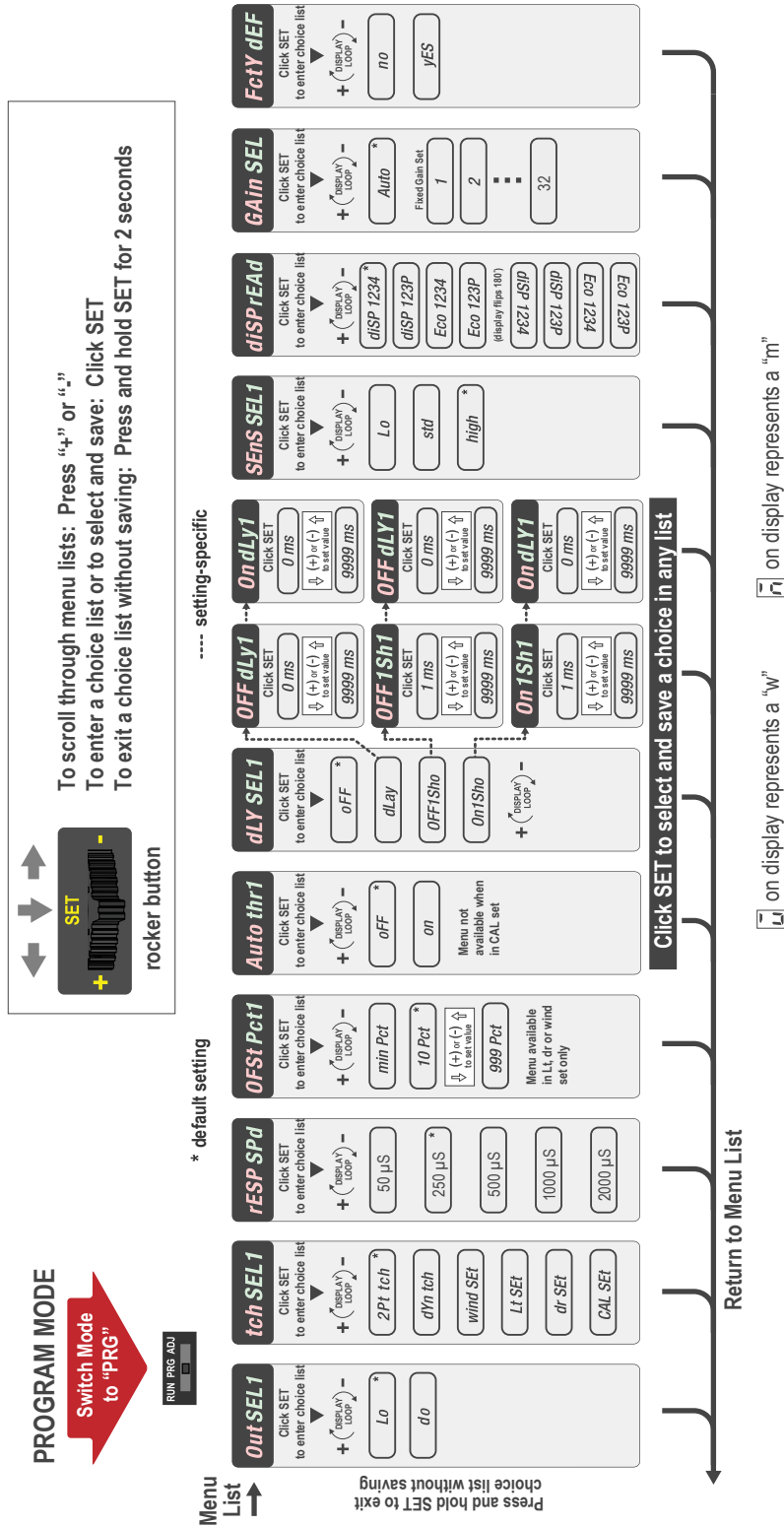

CH 2 Factory Default Settings

Setting	Factory Default
Out SEL2	LO

Continued on page 17

Continued from page 16

Setting	Factory Default
tch SEL2	2-pt tch
OFSt Pct2	10 Pct
Auto thr2	oFF
dLY SEL2	oFF
SEnS SEL2	high

CH 2 Program Mode Chart

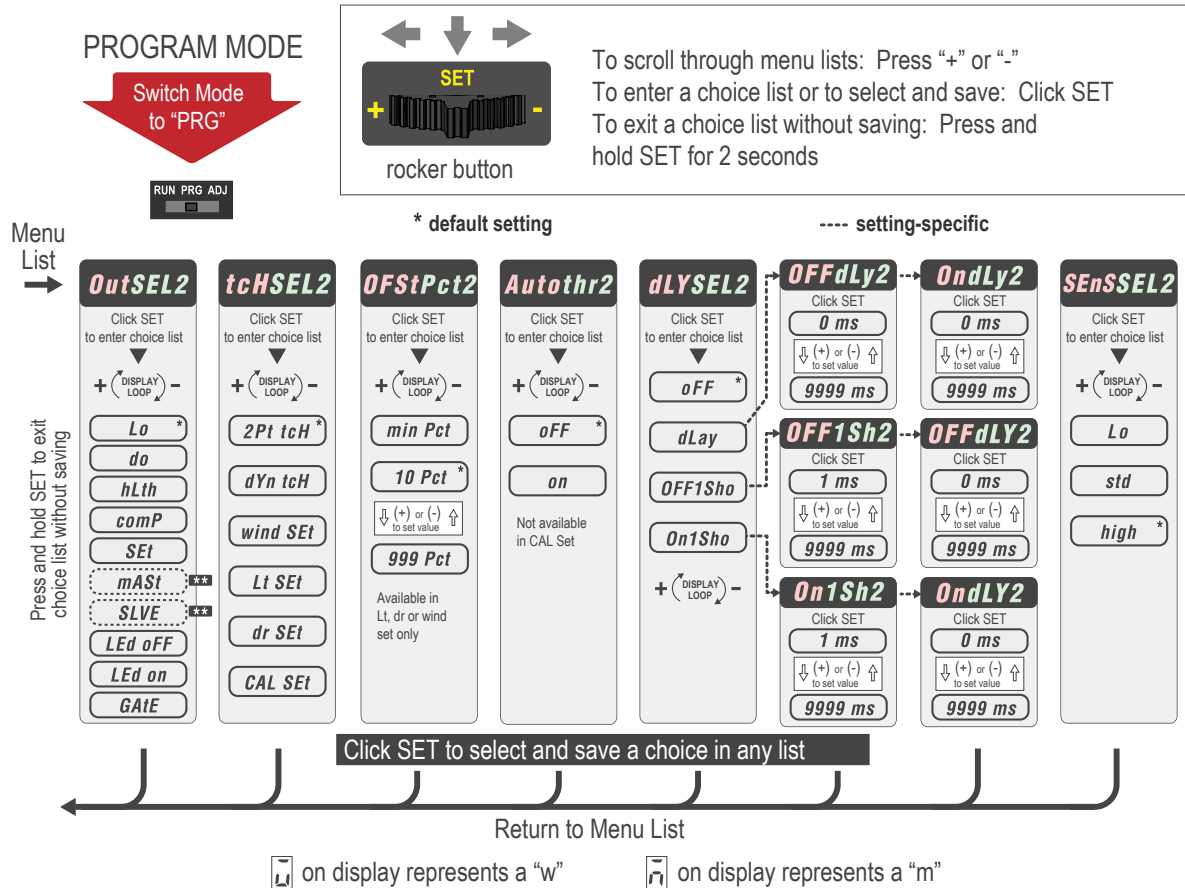

** If Master (mASt), indicate number of Slaves (1..6) under subsequent "totL SLAV" menu option
** If Slave (SLVE), indicate its address (Master address is 0) under subsequent "SLAV Addr" menu option

Output Selection



Both CH1 and CH2 can be programmed for either light operate (LO) or dark operate (DO). The Channel 2 menu includes additional options:

- Health (Health Mode Alarm)
- Comp (Complementary Programming)
- Set (sets Channel 2 wire as a remote input)
- Mast (selects this unit as the master and then allows you to enter the total number of slaves there will be)
- Sive (selects this unit as a slave and then allows you to enter this slave address)
- LED off
- LED on
- Gate

TEACH Selection

TEACH SEL 1

The DF-G2 can be programmed for one of the following TEACH/SET methods:

- Two-Point TEACH
- Dynamic TEACH
- Window SET
- Light SET
- Dark SET
- Calibration SET

NOTE: A TEACH Selection must be selected by programming before TEACH/SET methods can be used.

Response Speeds

Description	Response Speed	Repetition Period	Repeatability	Cross-Talk Avoidance	Energy Efficient Light Resistance	Maximum Range, Red ⁽²⁾	Maximum Range, IR850 ⁽³⁾
Fast	50 us	12 us	12 us	No	No	500	750
Standard	250 us	50 us	50 us	Yes	No	725	1300
Medium Range	500 us	80 us	80 us	Yes	No	900	1600
Long Range	1000 us	165 us	165 us	Yes	No	1100	2100
Long Range (with Immunity)	2000 us	165 us	165 us	Yes	Yes	1100	2100

Offset Percent

OFFSET Pct 1

The Offset Percent is used during the Window, Light, or Dark SET methods. The threshold(s) are positioned a programmable % offset from the taught condition.

The allowable offset percent range varies based on the response speed, TEACH method, and sensitivity settings as shown.

Teach Method	Response Speed	Sensitivity	Offset % Range
Window Set, Light Set	50 μs, 250 μs	High	2 to 98%
		Standard	5 to 95%
		Low	10 to 90%
	500 μs, 1000 μs, 2000 μs	High	1 to 99%
		Standard	2 to 98%
		Low	5 to 95%
Dark Set	50 μs, 250 μs	High	2 to 999%
		Standard	5 to 999%
		Low	10 to 999%
	500 μs, 1000 μs, 2000 μs	High	1 to 999%
		Standard	2 to 999%
		Low	5 to 999%

Auto Thresholds

Auto Thr 1

Auto Thresholds can be programmed to be ON/OFF. The Auto Thresholds algorithm continuously tracks slow changes in the taught condition(s), and optimizes the threshold(s) to provide for reliable sensing. For Two-Point and Dynamic TEACH, the

⁽²⁾ Excess Gain = 1 at High Sensitivity setting; opposed mode sensing using PIT46U plastic fiber

⁽³⁾ Excess Gain = 1 at High Sensitivity setting; opposed mode sensing using IT.83.3ST5M6 glass fiber

algorithm optimizes the threshold to be centered between the light and dark conditions. For Window, Light, and Dark SET, the algorithm optimizes the threshold(s) to maintain the programmed Offset Percent from the taught condition.

- After programming Auto Thresholds to ON, it is highly recommended to re-perform the TEACH/SET method
- Manual Adjustments are disabled when Auto Thresholds are ON
- Auto Thresholds are automatically disabled in Calibration SET (see "Calibration SET" on page 29)
- Severe contamination/changes in the taught condition can prevent the Auto Thresholds algorithm from optimizing the threshold(s). If this occurs, the DF-G2 enters a **Threshold Alert** or **Threshold Error** state. See "Troubleshooting" on page 35 for more explanation.

Delays/Timers

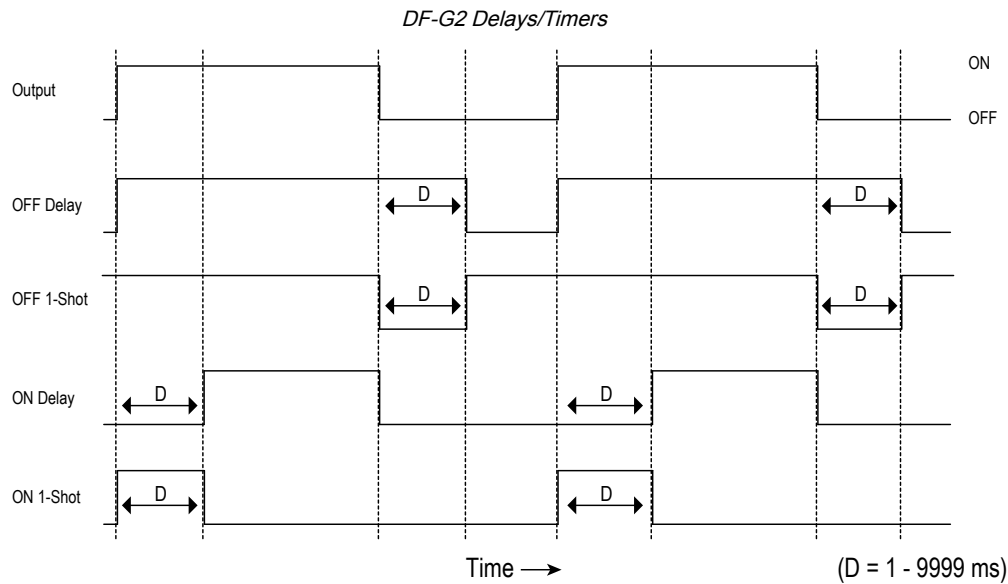

ON/OFF Delays and ON/OFF One-Shot timers can be programmed between 1 - 9999 ms (a value of 0 disables the delay/timer). "Figure: DF-G2 Delays/Timers " on page 19 defines how the delays/timers affect the output behavior.

Some combinations of delays/timers are not allowed. The DF-G2 programming menu automatically disables invalid combinations of delays/timers.

The following table shows the allowable combinations of delays/timers:

	OFF Delay	OFF One-Shot Timer	ON Delay	ON One-Shot Timer
OFF Delay	-	OK	OK	N/A
OFF One-Shot Timer	OK	-	N/A	N/A
ON Delay	OK	N/A	-	OK
ON One-Shot Timer	N/A	N/A	OK	-

Sensitivity Selection

- high—High sensitivity. Use this setting for low-contrast sensing
- Std—Standard sensitivity
- Lo—Low sensitivity. Use this setting to stabilize the output in high-vibration applications

Display Readout



The readout of the digital displays can be programmed for the following options:

- Signal/Threshold readout - Numeric (1234) or % (123P)

- ECO mode - Enabled or Disabled (ECO mode dims the displays to reduce current consumption)
- Display Orientation - Normal (1234) or Flipped (ƭƷƚ)

Gain Selection



The DF-G2 can operate in Auto Gain mode or the Gain can be fixed to be in Gain . In Auto Gain, the DF-G2 optimizes the gain during a TEACH/SET method for the presented condition(s). While viewing the fixed gains in the Gain Selection choice list, the DF-G2 will automatically switch to the selected gain and display the measured signal on the Red display. This allows for easy and quick evaluation of the fixed gain mode.

Factory Defaults



The Factory Defaults menu allows the DF-G2 to be easily restored back to original factory default settings (see **Factory Default Settings** in [Specifications](#)).

Remote Input

Use the input wire to program the sensor remotely. To program the sensor using the input wire, remote input must be enabled (inPT SEL = SET). The remote input provides limited programming options (see the figure below). Pulse the remote input according to the figures and the instructions provided in this manual.

NOTE: For NPN models, the remote input pulses are active low as shown in the following figures. For PNP models, the remote input pulses are active high and are inverted from the following figures.

Single Output — Remote Input Flowchart

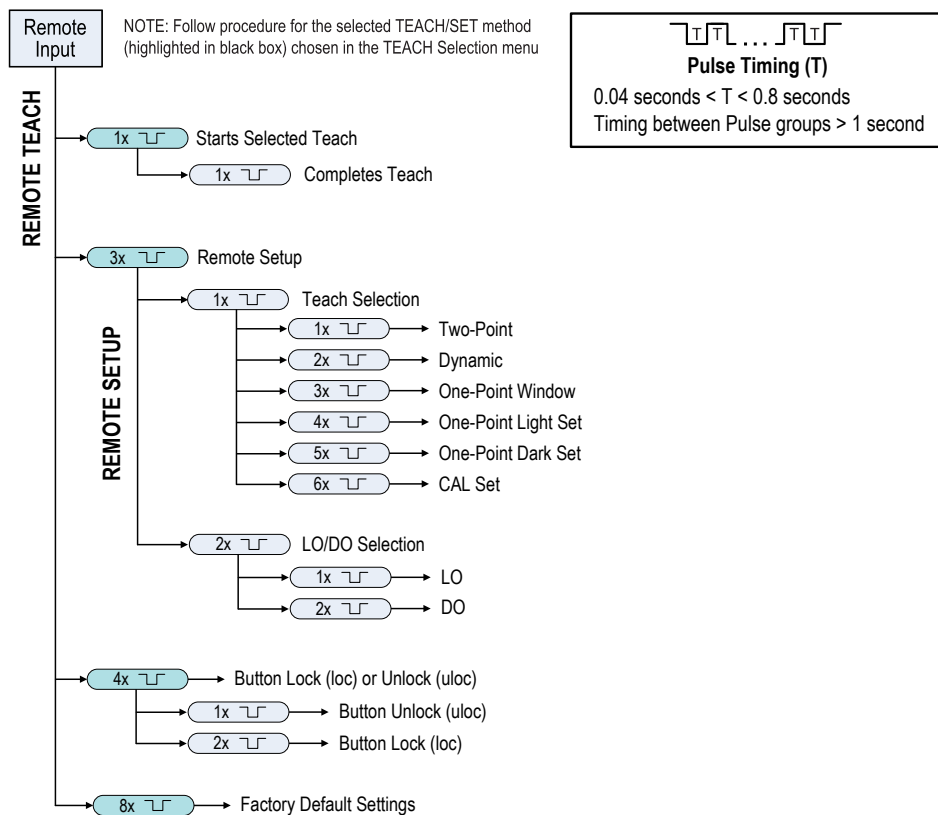

Sync Master/Slave

Up to seven DF-G2 High Speed Expert Dual Display Fiber Amplifier with Dual Discrete Outputs and IO Link sensors may be used together in a single sensing application. To eliminate crosstalk between the sensors, configure one sensor to be the

master and the remaining sensors to be the slaves. In this mode, the sensors alternate taking measurements and the response speed is 2 ms.

NOTE: Note: In this mode, all sensors must either be NPN or PNP output models.

1. Configure the first sensor as the Master (inPt SEL = MAST).
2. In the Master sensor set-up, enter the total number of Slave sensors you will be using (tOtL SLAV = 1 - 6).
3. For each Slave sensor used, configure the input as a Slave (inPt SEL = SLVE).
4. Give each Slave its own identifying address (SLAV Addr = 1 - 6).
5. Connect the Input wires of the Master and all of the Slaves together.

NOTE: Note: Giving two Slave sensors the same address will cause them to fire their emitters at the same time in the firing sequence.

Adjust Mode



Sliding the RUN/PRG/ADJ mode switch to the ADJ position allows the user to perform Expert TEACH/SET methods and Manual Adjustment of the threshold(s).

NOTE: For the Dual Output models, when teaching CH2, the gain setting will be the same as the gain setting made during the CH1 teach. Reteaching CH1 may invalidate the previous CH2 teach.

TEACH Procedures

The instruction manual has detailed instructions for these TEACH modes:

- Two-Point TEACH
- Dynamic TEACH
- Window SET
- Light SET
- Dark SET
- Calibration SET

Two-Point TEACH

- Establishes a single switching threshold
- Threshold can be adjusted by using the "+" and "-" rocker button (Manual Adjust)

Two-Point TEACH is used when two conditions can be presented statically to the sensor. The sensor locates a single sensing threshold (the switch point) midway between the two taught conditions, with the Output ON condition on one side, and the Output OFF condition on the other.

The Output ON and OFF conditions can be reversed by using the LO/DO (Light Operate/ Dark Operate) switch.

Two-Point TEACH and Manual Adjust

Moves the switching threshold value up or down to make adjustments

- Slide Mode switch to ADJ to enter Adjust mode
- Press "+" to increase; press "-" to decrease
 - GREEN display shows the switching threshold value
 - 2 seconds after adjustment, the GREEN display will flash 3 times to confirm
- Slide Mode switch to RUN to complete the operation

Two-Point TEACH (Light Operate shown)

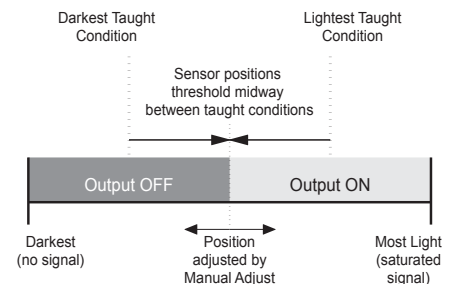



REMEMBER: Manual adjustments are disabled when Auto Thresholds are ON



Follow these steps to perform a Two-Point TEACH:

NOTE: TEACH Selection must be programmed to 2Pt tch.



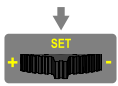

1. Enter Adjust mode.

Method	Action	Result
SET Button ⁽⁴⁾	Set the Mode switch to ADJ.	 Display: Red - Signal Level; Green - Threshold 
Remote Input ⁽⁵⁾	No action is required; the sensor is ready for the Two-Point TEACH method	

2. Teach the first condition.

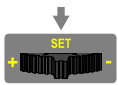
Method	Action	Result
SET Button	a. Present the first condition. b. Click the SET rocker button.	 Display: Flashes "2Pt tch" then holds on "1234 2nd" 
Remote Input	a. Present the first condition. b. Single-pulse the remote input.	

3. Teach the second condition.

Method	Action	Result
SET Button	a. Present the second condition. b. Click the SET rocker button.	 TEACH Accepted Displays alternate "PASS" and % Minimum Difference ⁽⁶⁾ ; Sensor returns to Adjust mode 
Remote Input	a. Present the second condition. b. Single-pulse the remote input.	 TEACH Not Accepted Displays alternate "FAIL" and % Minimum Difference ⁽⁶⁾ ; Sensor returns to Adjust mode 

4. Return to Run mode.

Method	Action	Result
SET Button	Move the Mode switch to RUN	 Display: Red - Signal Level; Green - Threshold 
Remote Input	No action is required; sensor returns to RUN mode automatically	

⁽⁴⁾ SET Button: 0.04 seconds ≤ "Click" ≤ 0.8 seconds

⁽⁵⁾ Remote Input: 0.04 seconds ≤ T ≤ 0.8 seconds

⁽⁶⁾ See "Troubleshooting" on page 35 for more explanation of the % Minimum Difference displayed after the Two-Point TEACH method.

Dynamic TEACH

- Teaches on-the-fly
- Establishes a single switching threshold
- Threshold can be adjusted using "+" and "-" rocker button (Manual Adjust)

Dynamic TEACH is best used when a machine or process may not be stopped for teaching. The sensor learns during actual sensing conditions, taking multiple samples of the light and dark conditions and automatically setting the threshold at the optimum level.

The output ON and OFF conditions can be reversed using the LO/DO switch.

Dynamic TEACH and Manual Adjust

Moves switching threshold value up or down to make adjustments

- Slide Mode switch to ADJ to enter Adjust mode
- Press "+" to increase; press "-" to decrease
 - GREEN display shows the switching threshold value
 - Two seconds after adjustment, GREEN display will flash three times to confirm
- Slide Mode switch to RUN to complete operation

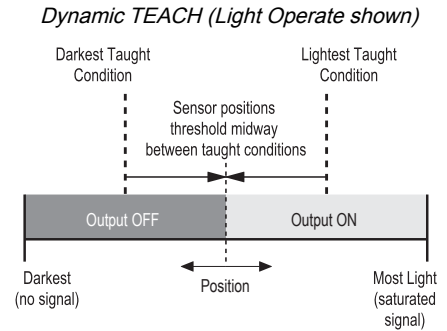



REMEMBER: Manual adjustments are disabled when Auto Thresholds are ON

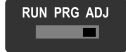

Follow these steps to perform **Dynamic TEACH**:

NOTE: TEACH Selection must be programmed to **dYn tch**.

1. Enter Adjust Mode.

Method	Action	Result
SET Button ⁽⁷⁾	Set Mode switch to ADJ	 Display: Red - Signal Level; Green - Threshold 
Remote Input ⁽⁸⁾	No action is required; the sensor is ready for Dynamic TEACH method	

2. Enter Dynamic TEACH.

Method	Action	Result
SET Button	Click the SET rocker button	 Display: Flashes "dYn tch" then holds on "1234 dYn" 
Remote Input	Single-pulse remote input	

3. Present ON and OFF Conditions.

Method	Action	Result
SET Button	Present ON and OFF conditions	Display: Red - Signal Level; Green - Threshold 



Continued on page 24

⁽⁷⁾ SET Button: 0.04 seconds ≤ "Click" ≤ 0.8 seconds
⁽⁸⁾ Remote Input: 0.04 seconds ≤ T ≤ 0.8 seconds

Continued from page 23

Method	Action	Result
Remote Input	Present ON and OFF conditions	

4. Exit Dynamic TEACH.

Method	Action	Result
SET Button	Click the SET rocker button	<p>TEACH Accepted Displays alternate "PASS" with % Minimum Difference⁽⁹⁾, Sensor returns to Adjust mode</p>  <p>TEACH Not Accepted Displays alternate "FAIL" with % Minimum Difference⁽⁹⁾, Sensor returns to Adjust mode</p> 
Remote Input	Single-pulse remote input	

5. Return to RUN Mode.

Method	Action	Result
SET Button	Move Mode switch to RUN	<p>Display: Red - Signal Level; Green - Threshold</p> 
Remote Input	No action is required; the sensor returns to RUN mode automatically	

Window SET

- Sets window thresholds that extend a programmable % offset above and below the presented condition
- All other conditions (lighter or darker) cause the output to change state
- Sensing window center can be adjusted using "+" and "-" rocker button (Manual Adjust)
- Recommended for applications where a product may not always appear in the same place, or when other signals may appear
- See Program Mode for programming the Offset Percent setting

Window SET (Light Operate shown)

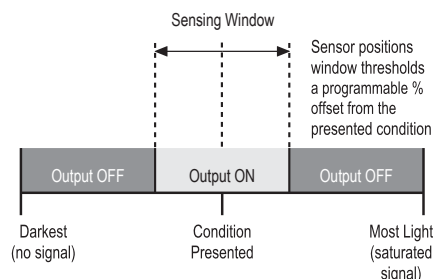

A single sensing condition is presented, and the sensor positions window thresholds a programmable % offset above and below the presented condition. In LO mode, Window SET designates a sensing window with the Output ON condition inside the window, and the Output OFF conditions outside the window.

Output ON and OFF conditions can be reversed using the LO/DO switch.

Window SET and Manual Adjust Window SET

Moves sensing window center value up or down to make adjustments

- Slide Mode switch to ADJ to enter Adjust mode
- Press "+" to increase; press "-" to decrease
 - GREEN display shows the sensing window center value
 - Two seconds after adjustment, the GREEN display will flash three times to confirm
- Slide Mode switch to RUN to complete operation

⁽⁹⁾ See "Troubleshooting" on page 35 for more explanation of the % Minimum Difference displayed after the Dynamic TEACH method.

REMEMBER: Manual adjustments are disabled when Auto Thresholds are ON





Follow these steps to perform a Window SET:

NOTE: TEACH Selection must be programmed to **wind SET**.



1. Enter Adjust Mode

Method	Action		Result
SET Button ⁽¹⁰⁾	Set Mode switch to ADJ		Display: Red - Signal Level; Green - Threshold 
Remote Input ⁽¹¹⁾	No action is required; the sensor is ready for Window SET method		

2. SET Sensing Condition

Method	Action		Result
SET Button	<ul style="list-style-type: none"> Present sensing condition Click the SET rocker button 		<p>Threshold Condition Accepted Displays read "wind SET" then alternate "PASS" with % Offset⁽¹²⁾; Sensor returns to Adjust mode</p>  <p>Threshold Condition Not Accepted</p> <p>Displays read "wind SET" then alternate "FAIL" with minimum % Offset⁽¹²⁾ for sensing condition; Sensor returns to Adjust mode</p> 
Remote Input	<ul style="list-style-type: none"> Present sensing condition Single-pulse the remote input 		

3. Return to RUN Mode

Method	Action		Result
SET Button	Move Mode switch to Run		<p>Display: Red - Signal Level; Green - Window Center (see "Figure: Upper and Lower Thresholds" on page 26 for instructions on how to display upper and lower thresholds)</p> 
Remote Input	No action is required; the sensor returns to Run mode automatically		

⁽¹⁰⁾ SET Button: 0.04 seconds ≤ "Click" ≤ 0.8 seconds

⁽¹¹⁾ Remote Input: 0.04 seconds ≤ T ≤ 0.8 seconds

⁽¹²⁾ See "Troubleshooting" on page 35 for more explanation of the % Offset displayed after the Window SET method

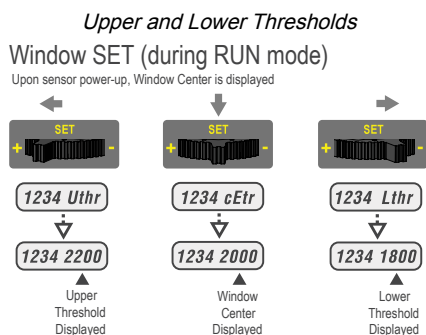

Light SET

- Sets a threshold a programmable % offset below the presented condition
- Changes output state on any condition darker than the threshold condition
- Threshold can be adjusted using "+" and "-" rocker button (Manual Adjust)
- Recommended for applications where only one condition is known, for example a stable light background with varying darker targets
- See Program Mode for programming the Offset Percent setting

A single sensing condition is presented, and the sensor positions a threshold a programmable % offset below the presented condition. When a condition darker than the threshold is sensed, the output either turns ON or OFF, depending on the LO/DO setting.

Light SET (Light Operate shown)

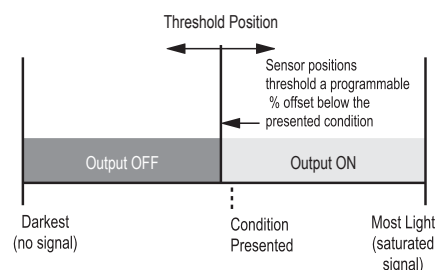

Light SET and Manual Adjust

Moves the switching threshold value up or down to make adjustments

- Slide Mode switch to ADJ to enter Adjust mode
- Press "+" to increase; press "-" to decrease
 - GREEN display shows the switching threshold value
 - Two seconds after adjustment, the GREEN display will flash three times to confirm
- Slide Mode switch to RUN to complete operation

REMEMBER: Manual adjustments are disabled when Auto Thresholds are ON

Follow these steps to perform a Light SET:

NOTE: TEACH Selection must be programmed to Lt Set.





1. Enter Adjust Mode

Method	Action	Result
SET Button ⁽¹³⁾	Set Mode switch to ADJ	Display: Red - Signal Level; Green - Threshold
Remote Input ⁽¹⁴⁾	No action is required; the sensor is ready for Light SET method	

2. SET Sensing Condition

⁽¹³⁾ SET Button: 0.04 seconds ≤ "Click" ≤ 0.8 seconds

⁽¹⁴⁾ Remote Input: 0.04 seconds ≤ T ≤ 0.8 seconds

Method	Action	Result
SET Button	<ul style="list-style-type: none"> Present sensing condition Click the SET rocker button 	<p>Threshold Condition Accepted Displays read "Lt SET" then alternate "PASS" with % Offset⁽¹⁵⁾; Sensor returns to Adjust mode</p> 
Remote Input	<ul style="list-style-type: none"> Present sensing condition Single-pulse the remote input 	<p>Threshold Condition Not Accepted</p> <p>Displays read "Lt SET" then alternate "FAIL" with minimum % Offset⁽¹⁵⁾ for sensing condition; Sensor returns to Adjust mode</p> 

3. Return to RUN Mode

Method	Action	Result
SET Button	Move Mode switch to RUN	 <p>Display: Red - Signal Level; Green - Threshold</p> 
Remote Input	No action is required; the sensor returns to RUN mode automatically	

Dark SET

- Sets a threshold a programmable % offset above the presented condition
- Any condition lighter than the threshold condition causes the output to change state
- Threshold can be adjusted using "+" and "-" rocker button (Manual Adjust)
- Recommended for applications where only one condition is known, for example, a stable dark background with varying lighter targets
- See Program Mode for programming the Offset Percent setting

Dark SET (Light Operate shown)

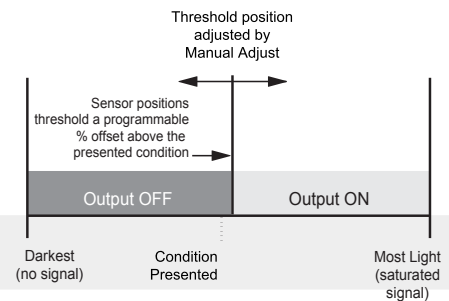

NOTE: Offset Percent MUST be programmed to **Minimum Offset** to accept conditions of no signal (0 counts).

A single sensing condition is presented, and the sensor positions a threshold a programmable % offset above the presented condition. When a condition lighter than the threshold is sensed, the output either turns ON or OFF, depending on the LO/DO setting.

Dark SET and Manual Adjust

Moves the switching threshold value up or down to make adjustments

- Slide Mode switch to ADJ to enter Adjust mode
- Press "+" to increase; press "-" to decrease
 - GREEN display shows the switching threshold value
 - Two seconds after adjustment, the GREEN display will flash three times to confirm
- Slide Mode switch to RUN to complete the operation

REMEMBER: Manual adjustments are disabled when Auto Thresholds are ON

⁽¹⁵⁾ See "Troubleshooting" on page 35 for more explanation of the % Offset displayed after the Light SET method





Follow these steps to perform a Dark SET:

NOTE: TEACH Selection must be programmed to **dr SET**.

1. Enter Adjust Mode.

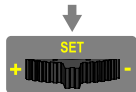
Method	Action	Result
SET Button ⁽¹⁶⁾	Set Mode switch to ADJ	 Display: Red - Signal Level; Green - Threshold 
Remote Input ⁽¹⁷⁾	No action is required; the sensor is ready for Dark SET method	

2. SET Sensing Condition.

Method	Action	Result
SET Button	<ul style="list-style-type: none"> Present sensing condition Click the SET rocker button 	 Threshold Condition Accepted Displays read "dr SET" then alternate "PASS" with % Offset ⁽¹⁸⁾ ; Sensor returns to Adjust mode 
Remote Input	<ul style="list-style-type: none"> Present sensing condition Single-pulse the remote input 	 Threshold Condition Not Accepted Displays read "dr SET" then alternate "FAIL" with minimum % Offset ⁽¹⁸⁾ for sensing condition; Sensor returns to Adjust mode 

3. Return to RUN Mode.

Method	Action	Result
SET Button	Move Mode switch to RUN	 Display: Red - Signal Level; Green - Threshold 
Remote Input	No action is required; the sensor returns to RUN mode automatically	

⁽¹⁶⁾ SET Button: 0.04 seconds ≤ "Click" ≤ 0.8 seconds

⁽¹⁷⁾ Remote Input: 0.04 seconds ≤ T ≤ 0.8 seconds

⁽¹⁸⁾ See "Troubleshooting" on page 35 for more explanation of the % Offset displayed after the Dark SET method

Calibration SET

- Sets a threshold exactly at the presented condition
- Threshold can be adjusted using "+" and "-" rocker button (Manual Adjust)

A single sensing condition is presented, and the sensor positions a threshold exactly at the presented condition. When a condition lighter than the threshold is sensed, the output either turns ON or OFF, depending on the LO/DO setting.

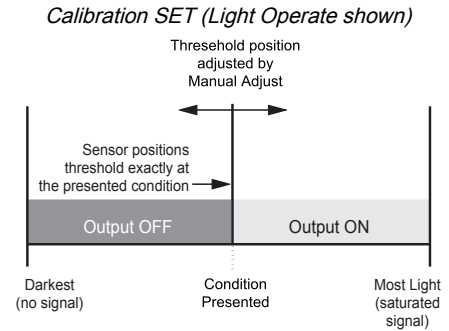

Calibration SET and Manual Adjust

Moves the switching threshold value up or down to make adjustments



- Slide Mode switch to ADJ to enter Adjust mode
- Press "+" to increase; press "-" to decrease
 - GREEN display shows the switching threshold value
 - Two seconds after adjustment, the GREEN display will flash three times to confirm
- Slide Mode switch to RUN to complete the operation

REMEMBER: Auto Thresholding is automatically disabled in Calibration SET





Follow these steps to perform a Calibration SET:

NOTE: TEACH Selection must be programmed to **CAL SET**.

1. Enter Adjust Mode



Method	Action	Result
SET Button ⁽¹⁹⁾	<ul style="list-style-type: none"> ◦ Set Mode switch to ADJ 	Display: Red - Signal Level; Green - Threshold 
Remote Input ⁽²⁰⁾	No action is required; the sensor is ready for Calibration SET method	

2. SET Sensing Condition

Method	Action	Result
SET Button	<ul style="list-style-type: none"> ◦ Present sensing condition ◦ Click the SET rocker button 	Threshold Condition Accepted Displays read "cAL SET" then flashes "PASS"; Sensor returns to Adjust mode 
Remote Input	<ul style="list-style-type: none"> ◦ Present sensing condition ◦ Single-pulse the remote input 	Threshold Condition Unacceptable Displays read "cAL SET" then flashes "FAIL"; Sensor returns to Adjust mode 

3. Return to RUN Mode

⁽¹⁹⁾ SET Button: 0.04 seconds ≤ "Click" ≤ 0.8 seconds
⁽²⁰⁾ Remote Input: 0.04 seconds ≤ T ≤ 0.8 seconds

Method	Action		Result
SET Button	Move Mode switch to RUN		Display: Red - Signal Level; Green - Threshold 
Remote Input	No action is required; the sensor returns to RUN mode automatically		

Chapter Contents

Chapter 4 IO-Link Interface

IO-Link® ⁽²¹⁾ is a point-to-point communication link between a master device and sensor. Use IO-Link to parameterize sensors and transmit process data automatically.

For the latest IO-Link protocol and specifications, see www.io-link.com.

Each IO-Link device has an IODD (IO Device Description) file that contains information about the manufacturer, article number, functionality etc. This information can be easily read and processed by the user. Each device can be unambiguously identified via the IODD as well as via an internal device ID. Download the DF-G2's IO-Link IODD package (p/n 18491) from Banner Engineering's website at www.bannerengineering.com.

Banner has also developed Add On Instruction (AOI) files to simplify ease-of-use between the DF-G2, multiple third-party vendors' IO-Link masters, and the Logix Designer software package for Rockwell Automation PLCs. Three types of AOI files for Rockwell Allen-Bradley PLCs are listed below. These files and more information can be found at www.bannerengineering.com.

Process Data AOIs—These files can be used alone, without the need for any other IO-Link AOIs. The job of a Process Data AOI is to intelligently parse out the Process Data word(s) in separate pieces of information. All that is required to make use of this AOI is an EtherNet/IP connection to the IO-Link Master and knowledge of where the Process Data registers are located for each port.

Parameter Data AOIs—These files require the use of an associated IO-Link Master AOI. The job of a Parameter Data AOI, when working in conjunction with the IO-Link Master AOI, is to provide quasi-realtime read/write access to all IO-Link parameter data in the sensor. Each Parameter Data AOI is specific to a given sensor or device.

IO-Link Master AOIs—These files require the use of one or more associated Parameter Data AOIs. The job of an IO-Link Master AOI is to translate the desired IO-Link read/write requests, made by the Parameter Data AOI, into the format a specific IO-Link Master requires. Each IO-Link Master AOI is customized for a given brand of IO-Link Master.

Add and configure the relevant Banner IO-Link Master AOI in your ladder logic program first; then add and configure Banner IO-Link Device AOIs as desired, linking them to the Master AOI as shown in the relevant AOI documentation.

⁽²¹⁾ IO-Link® is a registered trademark of PROFIBUS Nutzerorganisation e.V.

Chapter Contents

Quick-Disconnect Cordsets 32

Chapter 5 Accessories

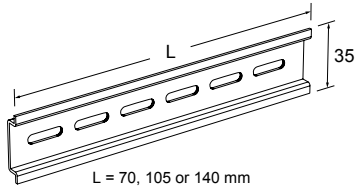
DIN-35-..	Models	Length (mm)
35 mm DIN Rail  <p>L = 70, 105 or 140 mm</p> <p>Hole center spacing: 35.1 Hole size: 25.4 x 5.3</p>	DIN-35-70 CAD Files: DXF , PDF , IGS , STP	70
	DIN-35-105 CAD Files: DXF , PDF , IGS , STP	105
	DIN-35-140 CAD Files: DXF , PDF , IGS , STP	140
	DIN-35-180 CAD Files: DXF , PDF , IGS , STP	180
	DIN-35-220 CAD Files: DXF , PDF , IGS , STP	220

SA-DIN-CLAMP

- Pair of metal DIN rail end stops; slide onto DIN rail at either side of the sensor stack
- Combination (#2 Phillips, #8 standard slotted) set screw

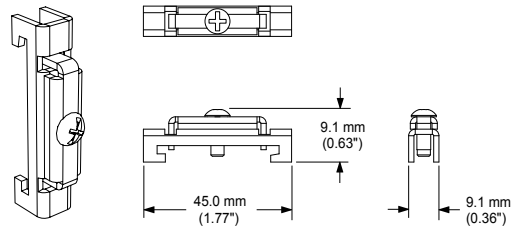

SA-DIN-BRACKET

- Plastic bracket with mounting screws
- CAD Files: [DXF](#), [PDF](#), [IGS](#), [STP](#)

Hole center spacing: A = 16, B = 25.4, C = 15.2
 Hole size: A = \varnothing 3.2, B = \varnothing 3.3, C = \varnothing 4.4

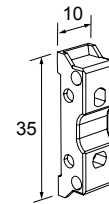

SA-DIN-BRACKET-10

- Package of 10 plastic brackets with mounting screws
- CAD Files: [DXF](#), [PDF](#), [IGS](#), [STP](#)

Hole center spacing: A = 16, B = 25.4, C = 15.2
 Hole size: A = \varnothing 3.2, B = \varnothing 3.3, C = \varnothing 4.4

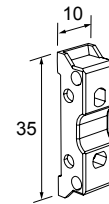

Quick-Disconnect Cordsets

All measurements are listed in millimeters, unless noted otherwise. The measurements provided are subject to change.

4-Pin Single-Ended M12 Female Cordsets					
Model	Length	Style	Dimensions	Pinout (Female)	
MQDC-406	2 m (6.56 ft)	Straight			1 = Brown 2 = White 3 = Blue 4 = Black 5 = Not used
MQDC-415	5 m (16.4 ft)				
MQDC-430	9 m (29.5 ft)				
MQDC-450	15 m (49.2 ft)	Right-Angle			1 = Brown 2 = White 3 = Blue 4 = Black
MQDC-406RA	2 m (6.56 ft)				
MQDC-415RA	5 m (16.4 ft)				
MQDC-430RA	9 m (29.5 ft)				
MQDC-450RA	15 m (49.2 ft)				

4-Pin Single-Ended M8 Female Cordsets					
Model	Length	Style	Dimensions	Pinout (Female)	
PKG4M-2	2 m (6.56 ft)	Straight			1 = Brown 2 = White 3 = Blue 4 = Black
PKG4M-5	5 m (16.4 ft)				
PKG4M-9	9 m (29.52 ft)				
PKW4M-2	2 m (6.56 ft)	Right Angle			1 = Brown 2 = White 3 = Blue 4 = Black
PKW4M-5	5 m (16.4 ft)				
PKW4M-9	9 m (29.5 ft)				

4-Pin Single-Ended Snap-on M8 Female Cordsets					
Model	Length	Style	Dimensions	Pinout (Female)	
PKG4-2	2.03 m (6.66 ft)	Straight			1 = Brown 2 = White 3 = Blue 4 = Black
PKG4-5	5.03 m (16.5 ft)				
PKG4-10	10 m (32.9 ft)				

Continued on page 34

Continued from page 33

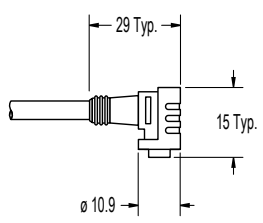
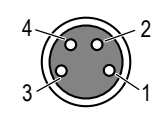
4-Pin Single-Ended Snap-on M8 Female Cordsets				
Model	Length	Style	Dimensions	Pinout (Female)
PKW4Z-2	2 m (6.56 ft)	Right-Angle		
PKW4Z-5	5 m (16.4 ft)			

Chapter Contents

Troubleshooting..... 35
 Banner Engineering Corp Limited Warranty..... 35

Chapter 6 Product Support and Maintenance

Troubleshooting

Manual Adjustments Disabled

Manual adjustments are disabled when Auto Thresholds are ON. If a manual adjustment is attempted while Auto Thresholds are ON, the Green display will flash Auto.

Percent Minimum Difference after TEACH

The Two-Point and Dynamic TEACH methods flash a % minimum difference on the displays after a PASS or FAIL.

Value	PASS/FAIL	Description
0 to 99%	FAIL	The difference between the taught conditions does not meet the required minimum
100 to 300%	PASS	The difference between the taught conditions just meets/exceeds the required minimum; minor sensing variables may affect sensing reliability
300 to 600%	PASS	The difference between the taught conditions sufficiently exceeds the required minimum; minor sensing variables will not affect sensing reliability
600% +	PASS	The difference between the taught conditions greatly exceeds the required minimum, and the operation is very stable operation

Percent Offset after SET

The Window, Dark, and Light SET methods flash a % offset on the displays after a PASS or FAIL.

SET Result	% Offset Meaning
PASS (with % Offset)	Displays the % offset used for the SET method
FAIL (with % Offset)	Displays the minimum required % offset necessary to PASS the SET method
FAIL (without % Offset)	The presented condition cannot be used for the SET method

Threshold Alert or Threshold Error

Severe contamination/changes in the taught condition can prevent the Auto Thresholds algorithm from optimizing the threshold(s).

State	Display	Description	Corrective Action
Threshold Alert	Alternates 	The threshold(s) cannot be optimized, but the sensor's output will still continue to function	Cleaning/correcting the sensing environment and/or a re-teach of the sensor is highly recommended
Threshold Error		The threshold(s) cannot be optimized, and the sensor's output will stop functioning	Cleaning/correcting the sensing environment and/or a re-teach of the sensor is required

Banner Engineering Corp Limited Warranty

Banner Engineering Corp. warrants its products to be free from defects in material and workmanship for one year following the date of shipment. Banner Engineering Corp. will repair or replace, free of charge, any product of its manufacture which, at the time it is returned to the factory, is found to have been defective during the warranty period. This warranty does not cover damage or liability for misuse, abuse, or the improper application or installation of the Banner product.

THIS LIMITED WARRANTY IS EXCLUSIVE AND IN LIEU OF ALL OTHER WARRANTIES WHETHER EXPRESS OR IMPLIED (INCLUDING, WITHOUT LIMITATION, ANY WARRANTY OF MERCHANTABILITY OR FITNESS FOR A PARTICULAR PURPOSE), AND WHETHER ARISING UNDER COURSE OF PERFORMANCE, COURSE OF DEALING OR TRADE USAGE.

This Warranty is exclusive and limited to repair or, at the discretion of Banner Engineering Corp., replacement. **IN NO EVENT SHALL BANNER ENGINEERING CORP. BE LIABLE TO BUYER OR ANY OTHER PERSON OR ENTITY FOR ANY EXTRA COSTS, EXPENSES, LOSSES, LOSS OF PROFITS, OR ANY INCIDENTAL, CONSEQUENTIAL OR SPECIAL DAMAGES RESULTING FROM ANY PRODUCT DEFECT OR FROM THE USE OR INABILITY TO USE THE PRODUCT, WHETHER ARISING IN CONTRACT OR WARRANTY, STATUTE, TORT, STRICT LIABILITY, NEGLIGENCE, OR OTHERWISE.**

Banner Engineering Corp. reserves the right to change, modify or improve the design of the product without assuming any obligations or liabilities relating to any product previously manufactured by Banner Engineering Corp. Any misuse, abuse, or improper application or installation of this product or use of the product for personal protection applications when the product is identified as not intended for such purposes will void the product warranty. Any modifications to this product without prior express approval by Banner Engineering Corp will void the product warranties. All specifications published in this document are subject to change; Banner reserves the right to modify product specifications or update documentation at any time. Specifications and product information in English supersede that which is provided in any other language. For the most recent version of any documentation, refer to: www.bannerengineering.com.

For patent information, see www.bannerengineering.com/patents.

